

light + motion surface installation instruction

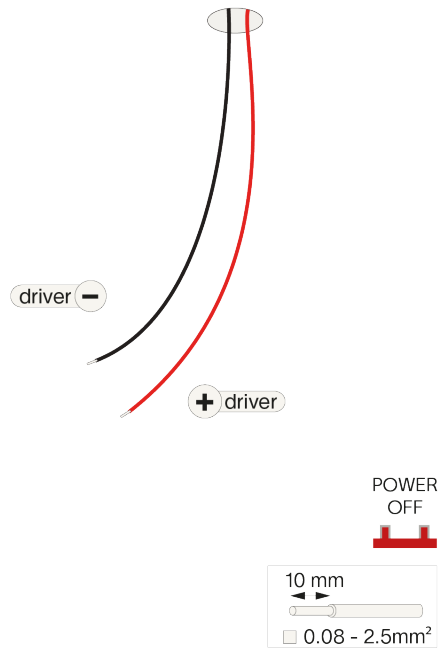

Step 1



Turn the power off.

Step 2

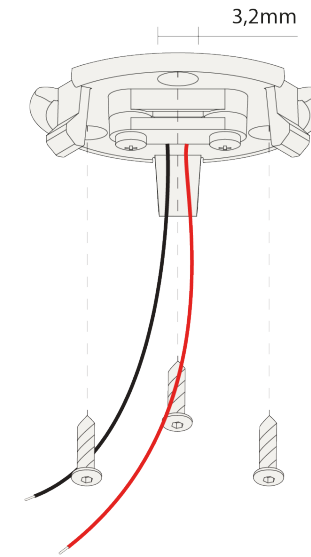

Fix the mounting plate on the ceiling with appropriate screws.

Step 3

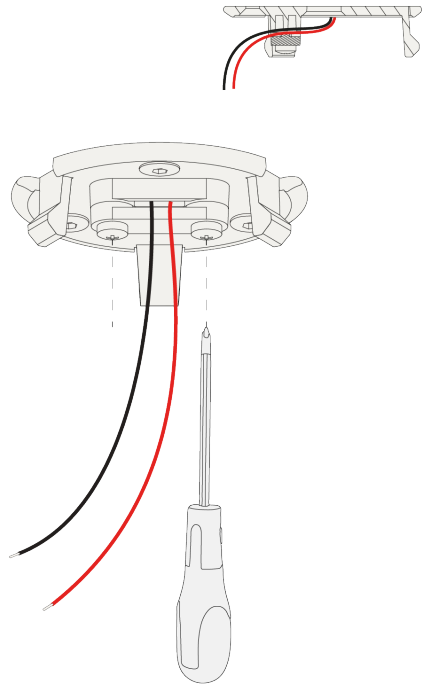

Tighten the wires through the strain relief and cut off the excess wire.

Step 4

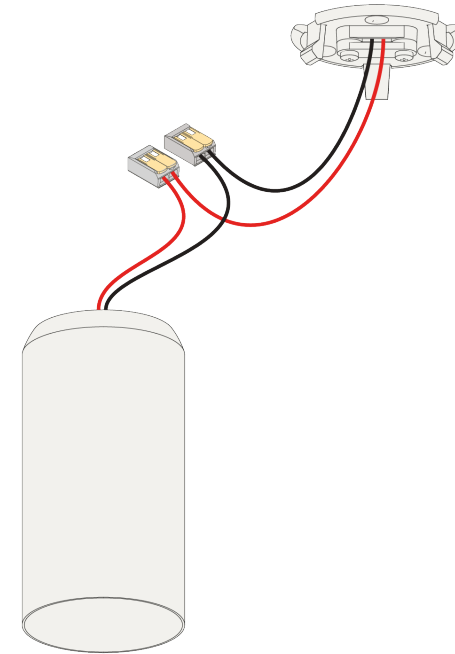

Connect the wires with the wago connectors for parallel connection, respect polarity combine with a prado LED-driver.

Step 5

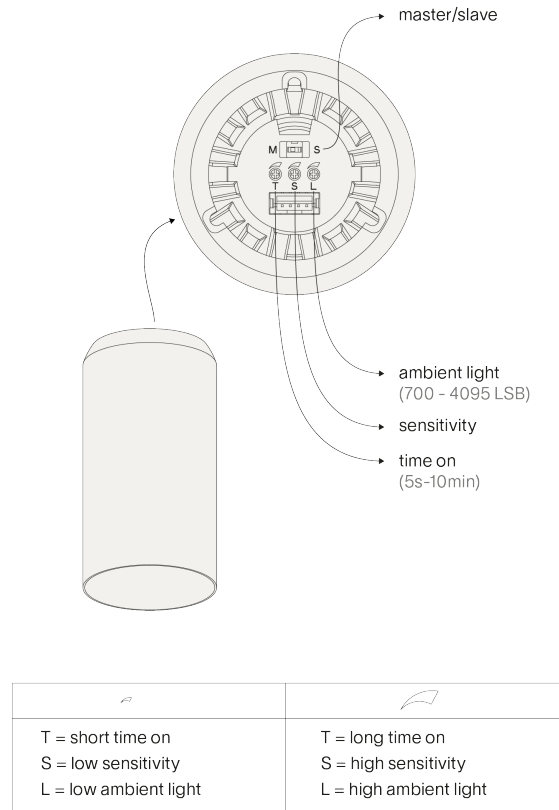

Standard settings:
 – Ambient light: 1700 LSB
 – sensitivity: no pets detectable
 – time on: 5min

If desired update standard settings with a screwdriver.

Step 6

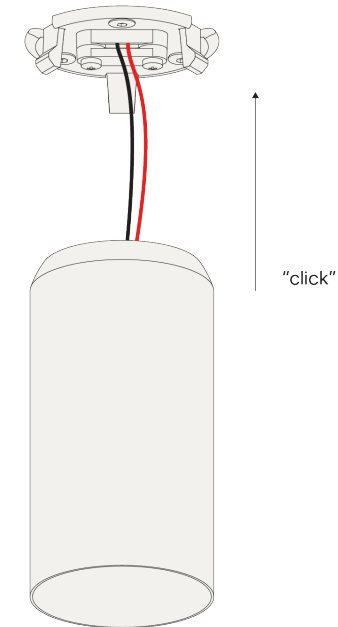

Click the luminaire onto the connection plate.

Step 7

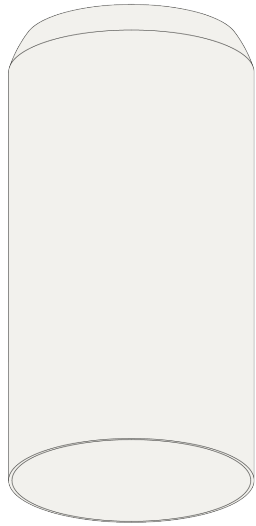

POWER
ON

Turn the power back on.

Step 8

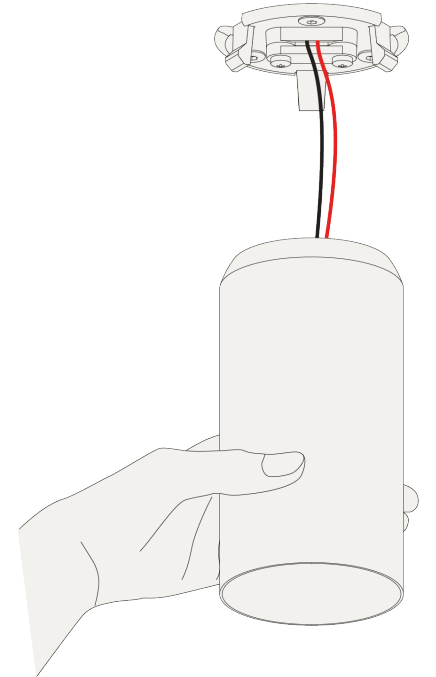

For both maintenance and the adjustment of settings, the luminaire can gently be removed from the ceiling.

